

SRS steps

- **1. RANS simulation**

- Run a RANS simulation in a coarse mesh.
- Understand the physics, adjust the boundary conditions and initial conditions, compare turbulence models.
- Compute integral length scales and refine the mesh accordingly.
- Create an interpolation field.
- You can perturb the interpolation field if deemed necessary.
- Refine mesh, interpolate the previous solution, and adjust the case setup.
- Rerun and do a critical analysis of the results.
- Move to URANS.

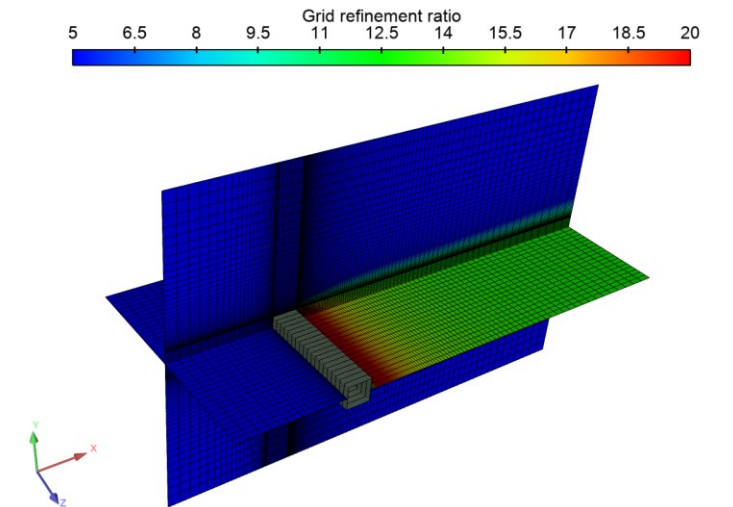
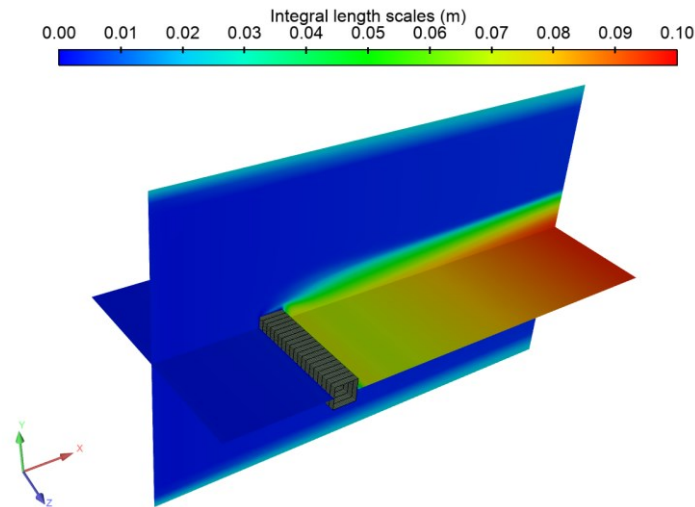
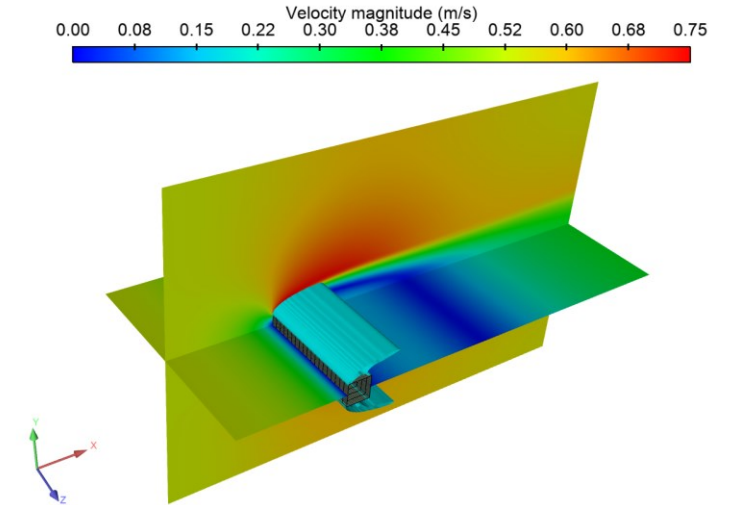
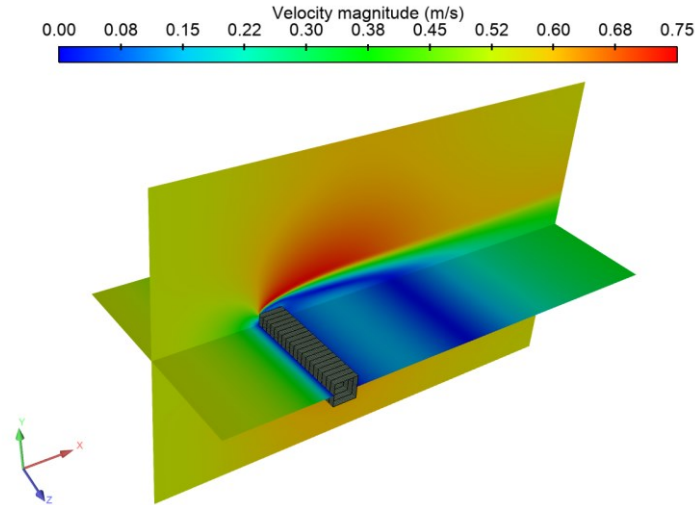

SRS steps

- **2. URANS simulation**

- Run an URANS simulation in an improved mesh.
- Use as starting point the interpolation field obtained from a RANS simulation (coarse or finer mesh).
- You can use a smooth field or a perturbed field.
- Set all the monitors and compute the solution.
- Turn on the unsteady statistics.
- Assess the mesh adequacy using the integral length scales and grid refinement ratio fields (mean and instantaneous values).
- Do a critical analysis of the results.
- Create an interpolation field and perturb it if deemed necessary.
- Move to LES.

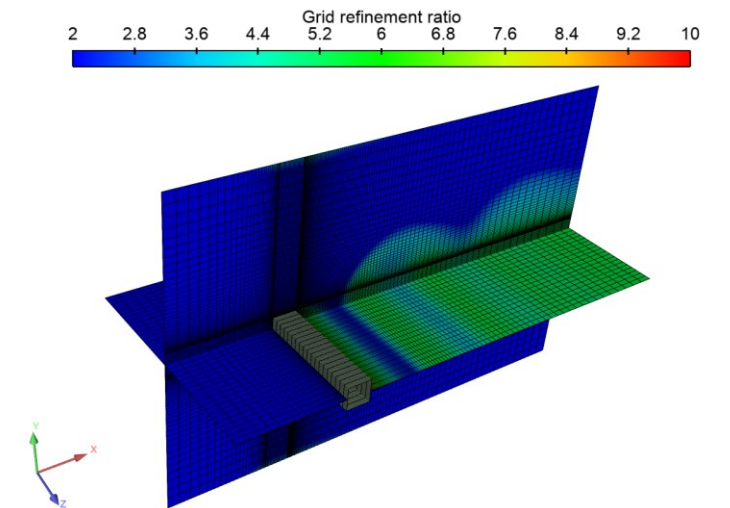
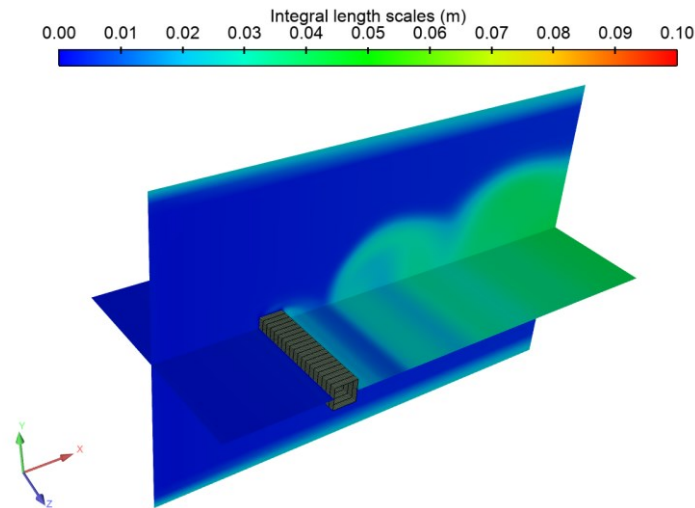
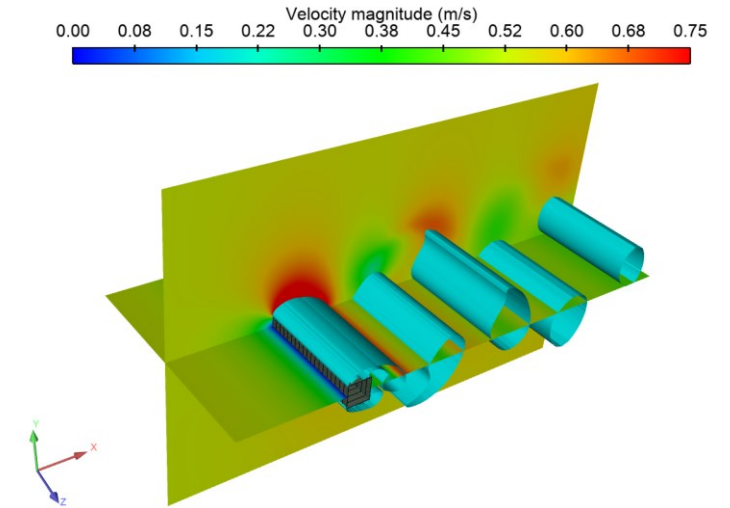
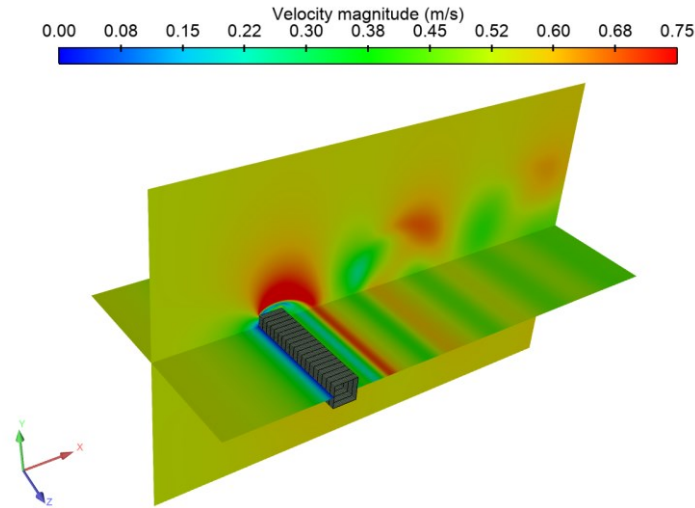

SRS steps

3. LES simulation

- Run the LES simulation using the mesh built during the RANS/URANS phase (precursor simulations)
- Use as starting point the interpolation field from a good URANS simulation.
- You can use a smooth field or a perturbed field.
- Set all the monitors and compute the solution.
- Turn on the unsteady statistics.
- Assess the mesh adequacy using the Pope criterion or similar criterion (mean and instantaneous values).
- Plot the TKE power spectrum at different locations and assess the quality of the LES simulation.
- Remember, a good LES should resolve at least 80% of the turbulent spectrum.

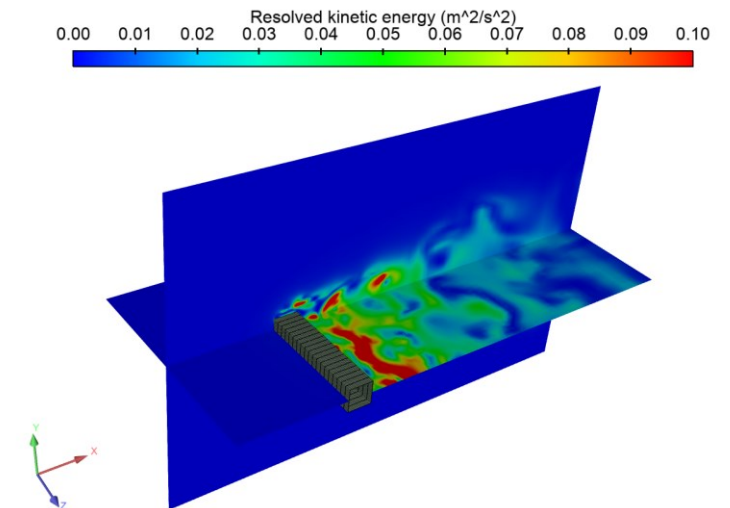
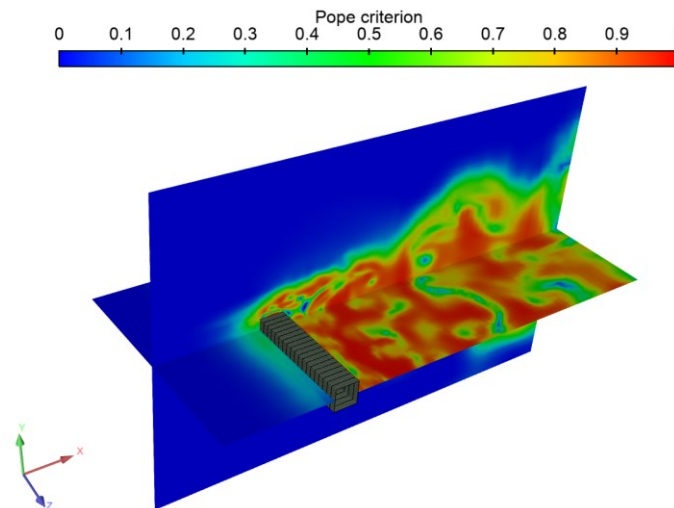
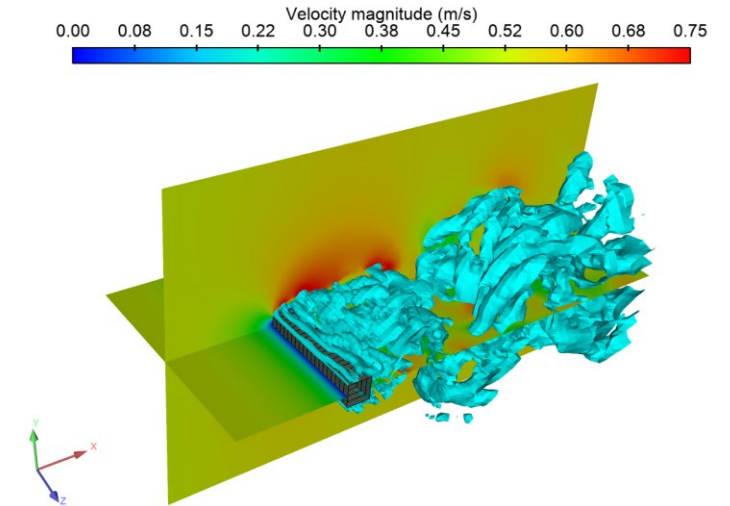
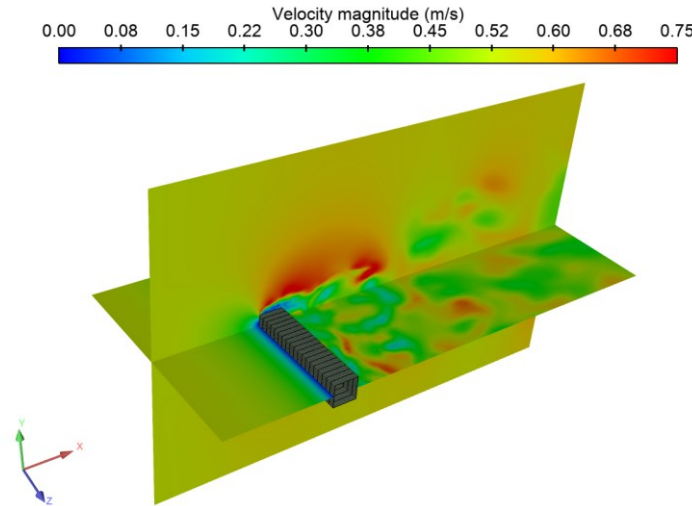

SRS steps

- **3. LES simulation**

- Remember, before launching the simulation it is very important to set all monitors.
- When running LES simulations there are many things that you must monitor, such as,
 - Resolved Reynolds stresses, resolved kinetic energy, Pope criterion, velocity fluctuations, forces, wall distance units, sub-grid scales fields, and so on.
- Again, do not forget to compute the unsteady statistics.
- Remember to limit the numerical diffusion.
- This means that you need to use a CFL number in the order of one and low dissipative numerical schemes.

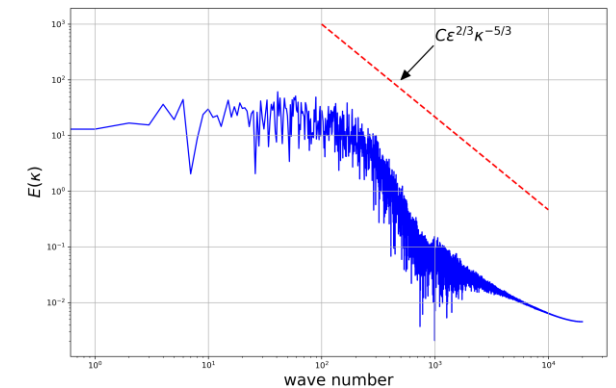
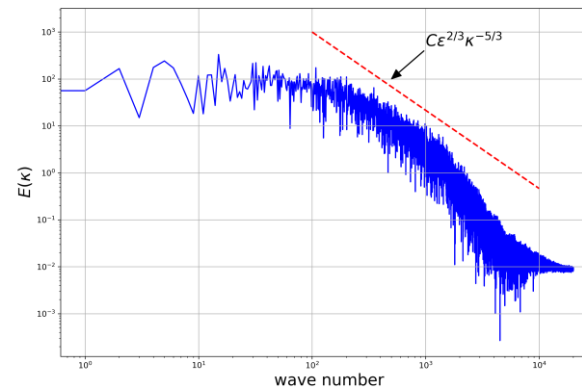
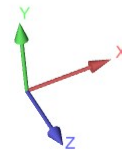
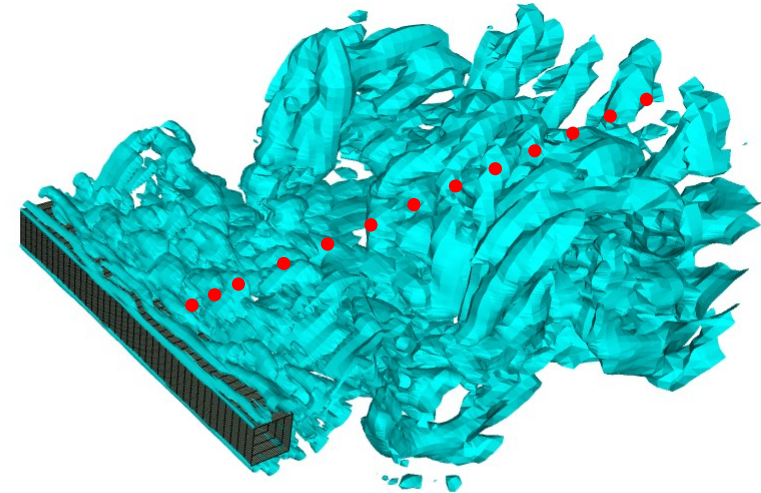

SRS steps

- **3. LES simulation**

- Finally, you will need to analyze the time series and compute the descriptive statistics.
- There is a lot signal processing involved.
- This is more important than the pretty colors.
- By the way, you need to run LES simulations for long times, so you get meaningful statistics.

